

JOB NAME _____ LOCATION _____
 PURCHASER _____ ORDER NO. _____
 ENGINEER _____
 SUBMITTED TO _____ FOR: Reference Approval Construction
 SUBMITTED BY _____ DATE _____

UNIT DESIGNATION: Schedule No. _____ MODEL NO. _____

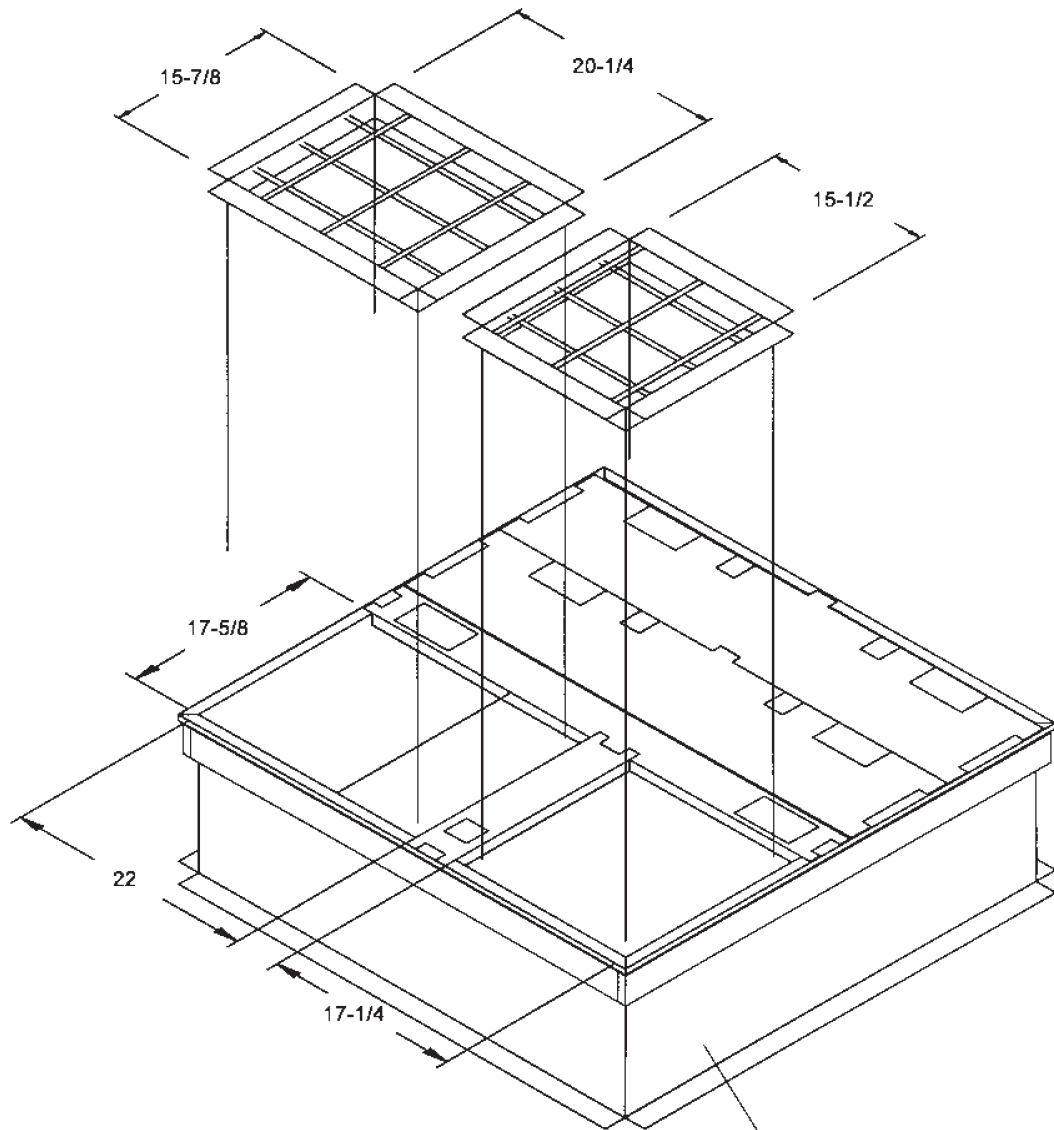

STANDARD ROOF CURB
(1RC0449 or 1RC0463)

NOTES:

1. Kit is made to fit duct opening size of roof curb.
2. Bars are welded on 6" centers.
3. Works with 1RC0449 and 1RC0463 Model Roof Curbs only.

Subject to change without notice. Printed in the U. S. A.

**BURGLAR BAR
MODEL 1BD0406**

FOR THE FOLLOWING UNITS: ACP-10, ACP-12, BUA, BUH, BUP, DPB, DPH, DYA, DYH, DYP, DYZ, HPP

FORM 036-22820-002-A-1003

Supersedes: 036-22820-001-A-0903

